

SECTION A-A
SCALE 1 : 3

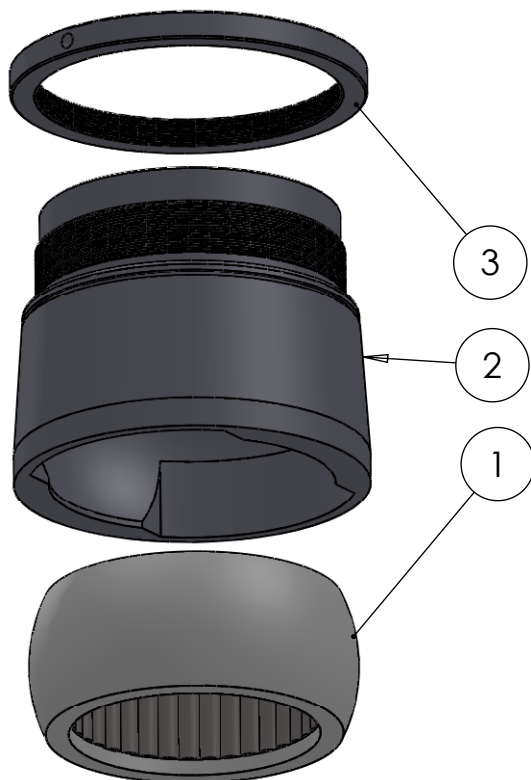
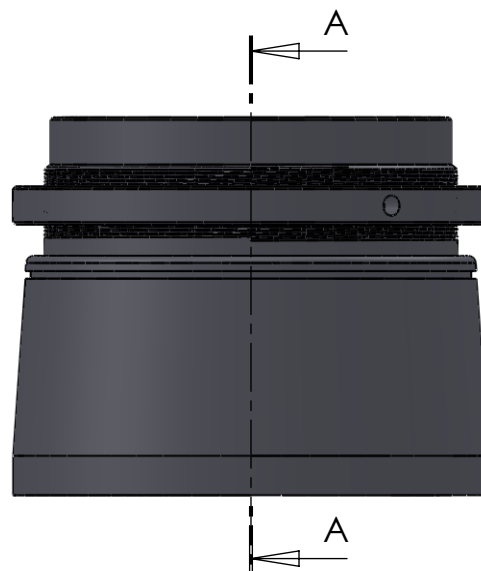

ITEM NO.	PART NUMBER	PART NAME	QTY.
1	M13-520-140	Ball with rollers for 5BT140	1
2	M53-120	House for 5BT116-5BT140	1
3	M54-120	Nut M164x2	1

DWG NR / NAME:

5BT140 / Conical SA lower roller bearing

PROJECT:

For $\varnothing 140$ mm shaft, max working load 6600 kg

DATE:

29.09.2011

NAME:

JR

SCALE / PAPER:

1:4 / A4

MATERIAL:

WEIGHT:

g

LOCATION:

REV:

BATCH NR:

REKV.NR / ORDRE NR:

ORDRE DATO:

LEV.DATO:

Jefa Rudder
SYSTEMS

JEFA MARINE A/S
NIMBUSVEJ 2
2670 GREVE. DENMARK

Tlf: +45 4615 5210 & Fax: +45 46155208
Email: info@jefa.com www.jefa.com

: /A.G. created 5BT140