

A

B

C

D

E

F

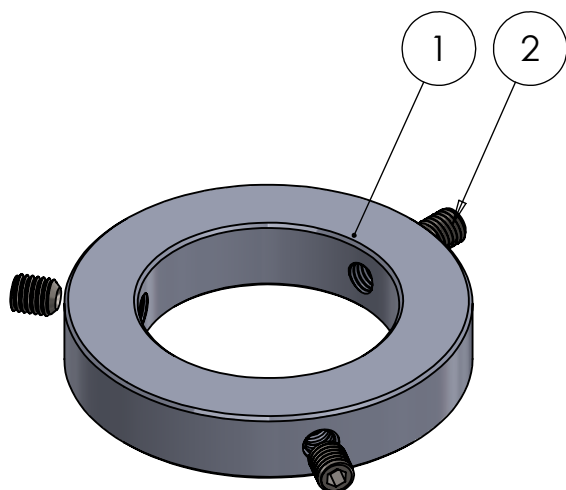
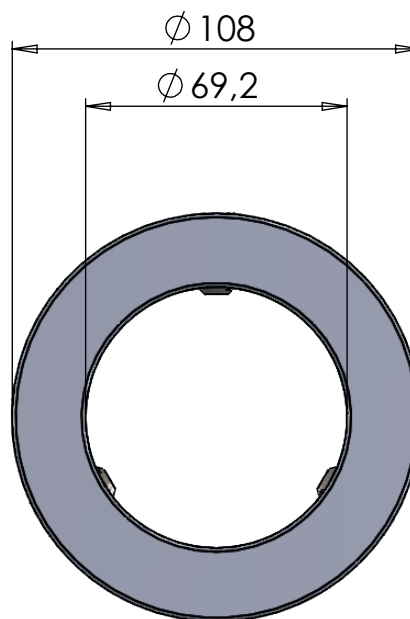

ITEM NO.	PART NUMBER	DESCRIPTION	QTY.
1	M57-069	Top / Lock ring 69mm	1
2	DIN 916 - M10 x 12-N	Socket ser screw cup point	3

DWG NR / NAME:

46069 / Top / Lock ring 69mm

BATCH NR:

PROJECT:

REKV.NR / ORDRE NR:

DATE: 30-04-2020

NAME: TML

SCALE / PAPER: 1:1 / A4

MATERIAL: WEIGHT: g

LOCATION:

ORDRE DATO:

MODIFY DATE: : /

REV:

LEV.DATO:

Jefa Rudder
S Y S T E M S

JEFA MARINE A/S
NIMBUSVEJ 2
2670 GREVE, DENMARK

Tlf: +45 4615 5210 & Fax: +45 46155208
Email: info@jefa.com www.jefa.com