

A

B

C

D

E

F

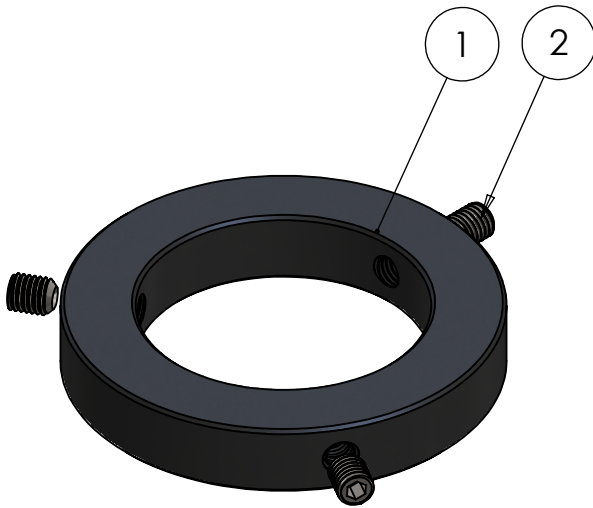
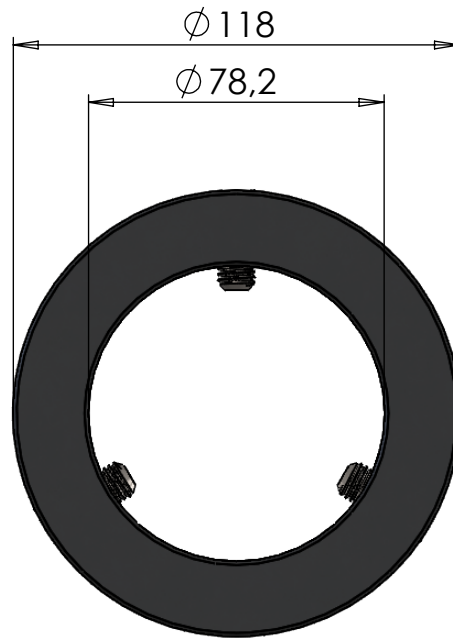

ITEM NO.	PART NUMBER	DESCRIPTION	QTY.
1	M57-078	Top / Lock ring 78mm	1
2	DIN 916 - M10 x 12-N	Socket ser screw cup point	3

DWG NR / NAME: **46078 / Top / Lock ring 78mm**

BATCH NR:

PROJECT:

REKV.NR / ORDRE NR:

DATE: **30-04-2020**

NAME: **TML**

SCALE / PAPER: **1:1 / A4**

MATERIAL: **g**

LOCATION:

ORDRE DATO:

MODIFY DATE: **: /**

REV:

LEV.DATO:

Jefa Rudder
SYSTEMS

JEFA MARINE A/S
NIMBUSVEJ 2
2670 GREVE, DENMARK

Tlf: +45 4615 5210 & Fax: +45 46155208
Email: info@jefa.com www.jefa.com