

A

B

C

D

E

F

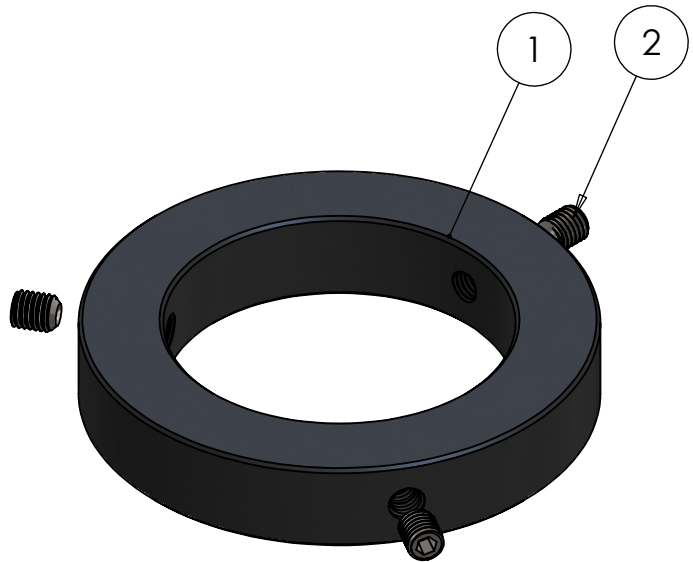
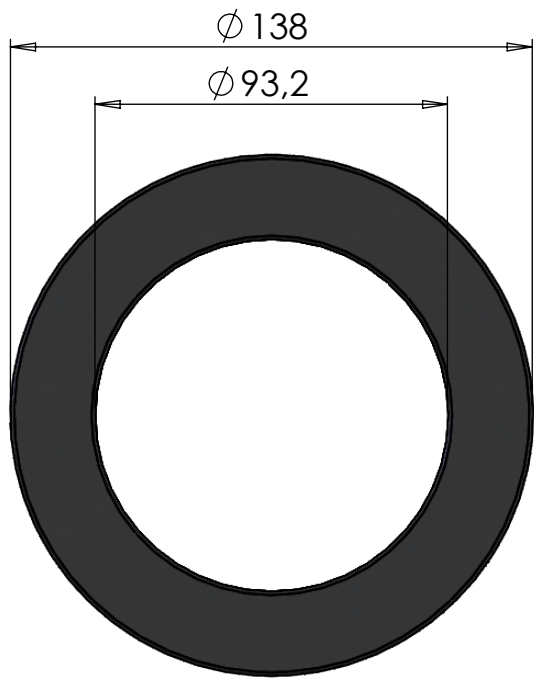

ITEM NO.	PART NUMBER	DESCRIPTION	QTY.
1	M57-093	Top / Lock ring 93mm	1
2	DIN 916 - M10 x 12-N	Socket ser screw cup point	3

DWG NR / NAME: <b>46093 / Top / Lock ring 93mm</b>				BATCH NR:	
PROJECT:				REKV.NR / ORDRE NR:	
DATE: <b>30-04-2020</b>	NAME: <b>TML</b>	SCALE / PAPER: <b>1:2 / A4</b>	MATERIAL: <b>g</b>	LOCATION:	ORDRE DATO:
MODIFY DATE: <b>: /</b>			WEIGHT:	REV:	LEV.DATO:



**Jefa Rudder**  
SYSTEMS  
JEFA MARINE A/S  
NIMBUSVEJ 2  
2670 GREVE, DENMARK  
Tlf: +45 4615 5210 & Fax: +45 46155208  
Email: info@jefa.com www.jefa.com