

A

B

C

D

E

F

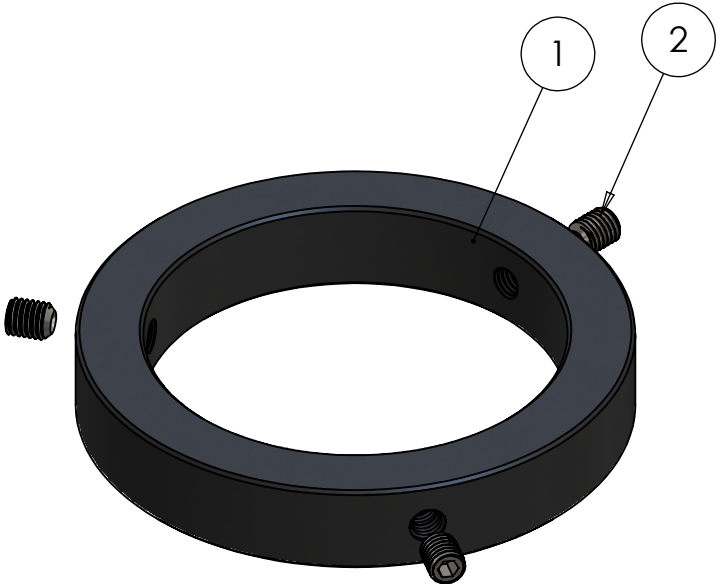
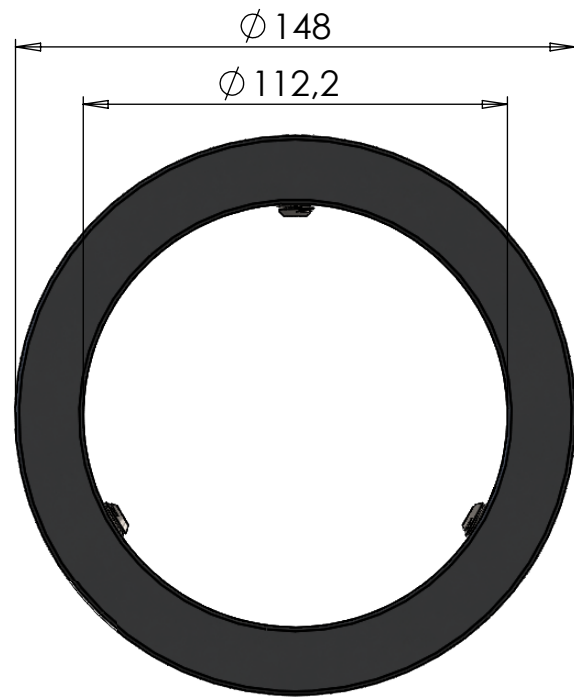

ITEM NO.	PART NUMBER	DESCRIPTION	QTY.
1	M57-112	Top / Lock ring 112mm	1
2	DIN 916 - M10 x 12-N	Socket set screw cup point	3

DWG NR / NAME: 46112 / Top / Lock ring 112mm				BATCH NR:	
PROJECT:				REKV.NR / ORDRE NR:	
DATE: 30-04-2020	NAME: TML	SCALE / PAPER: 1:2 / A4	MATERIAL: g	LOCATION:	ORDRE DATO:
MODIFY DATE: : /			WEIGHT:	REV:	LEV.DATO:

Jefa Rudder
S Y S T E M S
JEFA MARINE A/S
NIMBUSVEJ 2
2670 GREVE, DENMARK
Tlf: +45 4615 5210 & Fax: +45 46155208
Email: info@jefa.com www.jefa.com