

SECTION A-A
SCALE 1 : 3

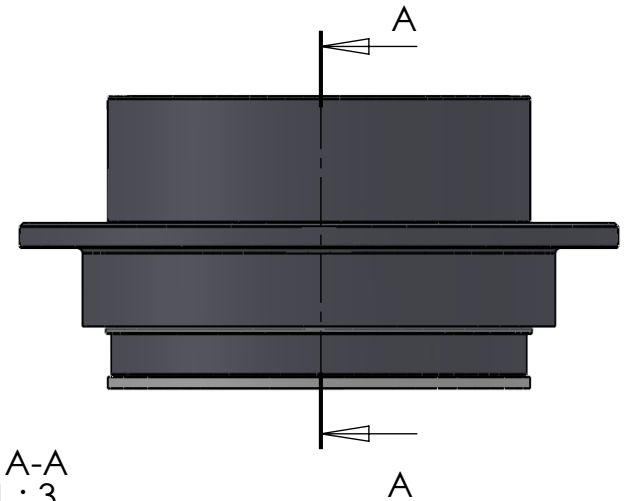

ITEM NO.	PART NUMBER	PART NAME	QTY.
1	M33-120	Outer house 4SF120-4SF139	1
2	M11-109	Ball 4SF120-4SF139	1
3	O-ring	ø160 x 2.5mm	1
4	M03-285	Delrin Lockring ø148,5 x ø131 x 1,75mm	2
5	M05-311	L-ring ø128 ø130.5 ø145	2
6	M01-308	Roller ø8.5 x 57mm	50
7	M35-117	Inner house 4SF120-4SF129	1
8	O-ring	ø150 x 2.5mm	1
9	M09-120	Alu lockring ø160.5 x ø169.5	1
10	M07-218	Washer ø128.5 ø168	1

DWG NR / NAME: 4SF128 / S-A top roller bearing				BATCH NR:		<i>Jefa Rudder</i> S Y S T E M S
PROJECT: Shaft Ø128mm, max working load 7900kg				REKV.NR / ORDRE NR:		
DATE: 20-01-2011	NAME: JR	SCALE / PAPER: 1:4 / A4	MATERIAL: WEIGHT: g	LOCATION:	ORDRE DATO:	JEFA MARINE A/S NIMBUSVEJ 2 2670 GREVE. DENMARK Tlf: +45 4615 5210 & Fax: +45 46155208 Email: info@jefa.com www.jefa.com
MODIFY DATE: : /				REV:	LEV.DATO:	