

SECTION A-A
SCALE 1 : 1.5

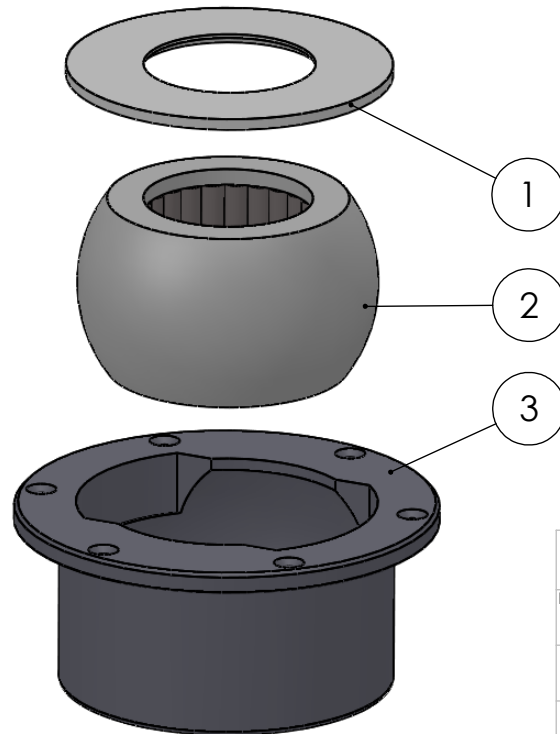

ITEM NO.	PART NUMBER	PART NAME	QTY.
1	M07-142-B	Washer, delrin $\varnothing 68,5 \times \varnothing 130 \times 4,5\text{mm}$	1
2	M13-214-67	Ball with Rollers for $\varnothing 67\text{mm}$	1
3	M51-120	House for 5T061-5T082	1

DWG NR / NAME:

5T067 / S-A top roller bearing

BATCH NR:

PROJECT:

Shaft $\varnothing 67\text{mm}$, max working load 3400-4600kg

REKV.NR / ORDRE NR:

DATE:

10.08.2016

NAME:

JR

SCALE / PAPER:

1:3 / A4

MATERIAL:

WEIGHT: g

LOCATION:

ORDRE DATO:

MODIFY DATE:

: /

REV:

LEV.DATO:

Jefa Rudder
S Y S T E M S

JEFA MARINE A/S
NIMBUSVEJ 2
2670 GREVE. DENMARK
Tlf: +45 4615 5210 & Fax: +45 46155208
Email: info@jefa.com www.jefa.com