

SECTION A-A  
SCALE 1 : 1.5

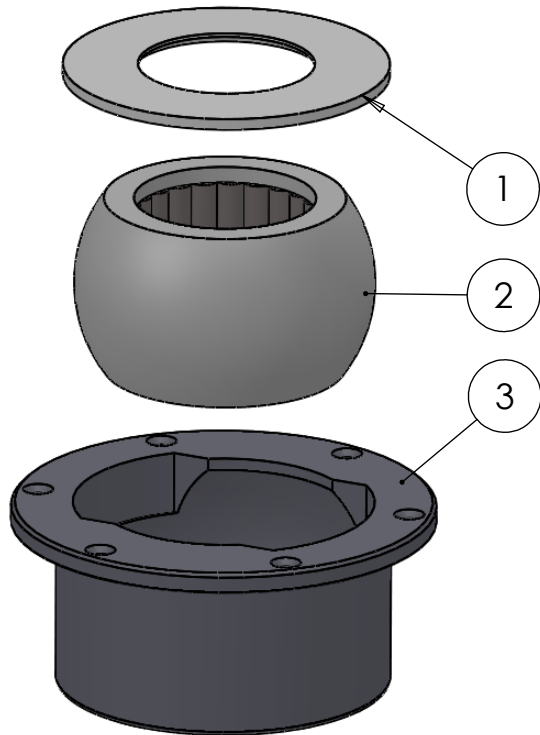

ITEM NO.	PART NUMBER	PART NAME	Default/ QTY.
1	M07-147	Washer, delrin $\varnothing 70,5 \times \varnothing 130 \times 4,5\text{mm}$	1
2	M13-216-70	Ball with rollers for $\varnothing 70\text{mm}$	1
3	M51-120	House for 5T061-5T082	1

DWG NR / NAME: <b>5T070 / S-A top roller bearing</b>				BATCH NR:		<i>Jefa Rudder</i> S Y S T E M S
PROJECT: Shaft $\varnothing 70\text{mm}$ , max working load 3400-4600kg				REKV.NR / ORDRE NR:		
DATE: 10.08.2016	NAME: JR	SCALE / PAPER: 1:3/ A4	MATERIAL: g	LOCATION:	ORDRE DATO:	JEFA MARINE A/S NIMBUSVEJ 2 2670 GREVE. DENMARK Tlf: +45 4615 5210 & Fax: +45 46155208 Email: info@jefa.com www.jefa.com
MODIFY DATE: /				REV:	LEV.DATO:	