

SECTION A-A
SCALE 1 : 1

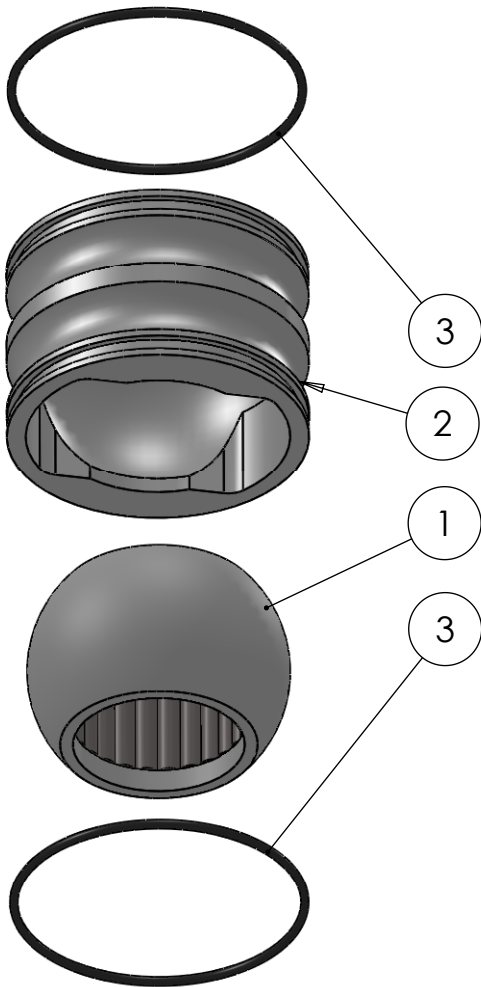

ITEM NO.	PART NUMBER	PART NAME	Default/ QTY.
1	M13-117-45	Ball with rollers	1
2	M48-090	House ø80mm for ø70mm ball	1
3	O-ring	ø75 x 2,5	2

DWG NR / NAME: 6BB080045 / S-A bottom Roller bearing

PROJECT: Shaft ø45mm

DATE: 31.01.2012

NAME: JR

SCALE / PAPER: 1:2 / A4

MATERIAL: WEIGHT: g

LOCATION:

BATCH NR:

REKV.NR / ORDRE NR:

ORDRE DATO:

LEV.DATO:

Jefa Rudder
SYSTEMS

JEFA MARINE A/S
NIMBUSVEJ 2
2670 GREVE, DENMARK

Tlf: +45 4615 5210 & Fax: +45 46155208
Email: info@jefa.com www.jefa.com

MODIFY DATE:

: /