

SECTION A-A  
SCALE 1 : 1

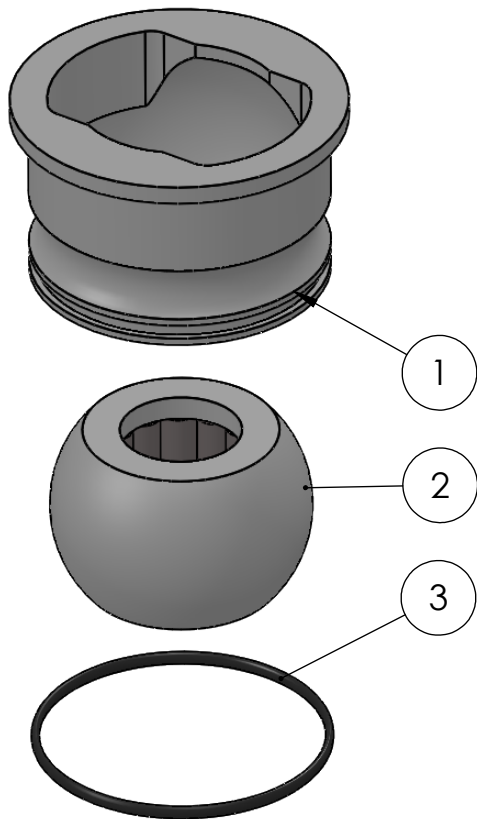

ITEM NO.	PART NUMBER	PART NAME	QTY.
1	M48-092	House ø80mm for ø70mm Ball	1
2	M13-104-32	Ball with Rollers for Ø32mm	1
3	O-ring	ø70 x 2,5	1

DWG NR / NAME:

**6BF080032 / S-A Top Roller bearing**

BATCH NR:

PROJECT:

Shaft Ø32mm

REKV.NR / ORDRE NR:

DATE:

12.09.2016

NAME:

JR

SCALE / PAPER:

1:2 / A4

MATERIAL: PETP

WEIGHT: g

LOCATION:

REV:

ORDRE DATO:

LEV.DATO:

MODIFY DATE:

: /

*Jefa Rudder*  
SYSTEMS

JEFA MARINE A/S  
NIMBUSVEJ 2  
2670 GREVE, DENMARK  
Tlf: +45 4615 5210 & Fax: +45 46155208  
Email: info@jefa.com www.jefa.com