

SECTION A-A
SCALE 1 : 1.2

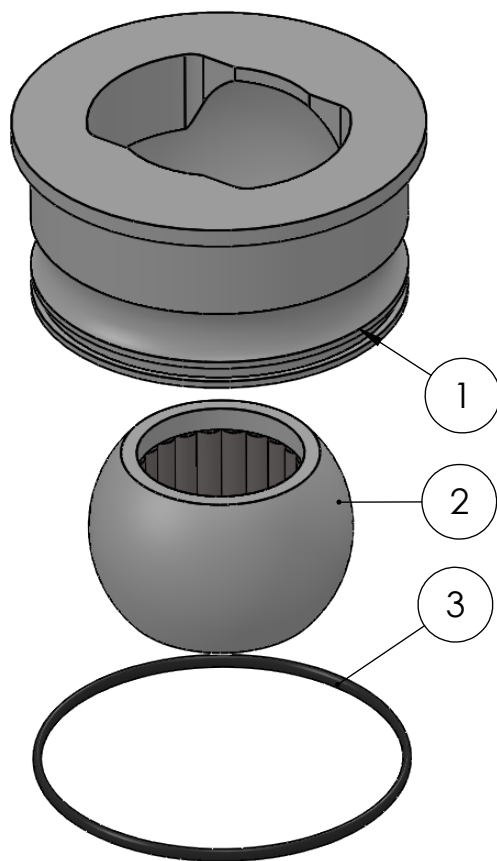
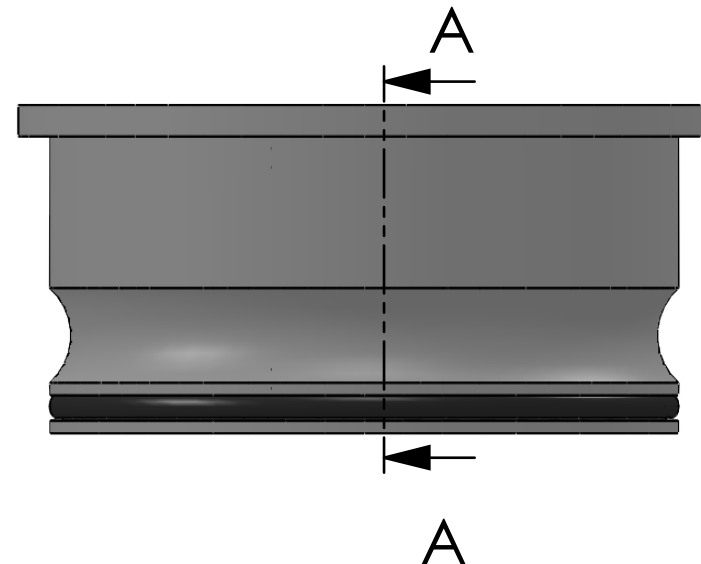

ITEM NO.	PART NUMBER	PART NAME	QTY.
1	M48-103	House $\varnothing 100\text{mm}$ for $\varnothing 70\text{mm}$ Ball	1
2	M13-115-43	Ball with rollers for $\varnothing 43\text{mm}$	1
3	O-ring	$\varnothing 90 \times 2,5\text{mm}$	1

DWG NR / NAME:

6BF100043 / S-A Top Roller bearing

BATCH NR:

PROJECT:

Shaft $\varnothing 43\text{mm}$

REKV.NR / ORDRE NR:

DATE:

12.09.2016

NAME:

JR

SCALE / PAPER:

1:2 / A4

MATERIAL: PETP

WEIGHT: g

LOCATION:

REV:

ORDRE DATO:

LEV.DATO:

MODIFY DATE:

: /

Jefa Rudder
SYSTEMS

JEFA MARINE A/S
NIMBUSVEJ 2
2670 GREVE, DENMARK
Tlf: +45 4615 5210 & Fax: +45 46155208
Email: info@jefa.com www.jefa.com