

SECTION A-A
SCALE 1 : 1.2

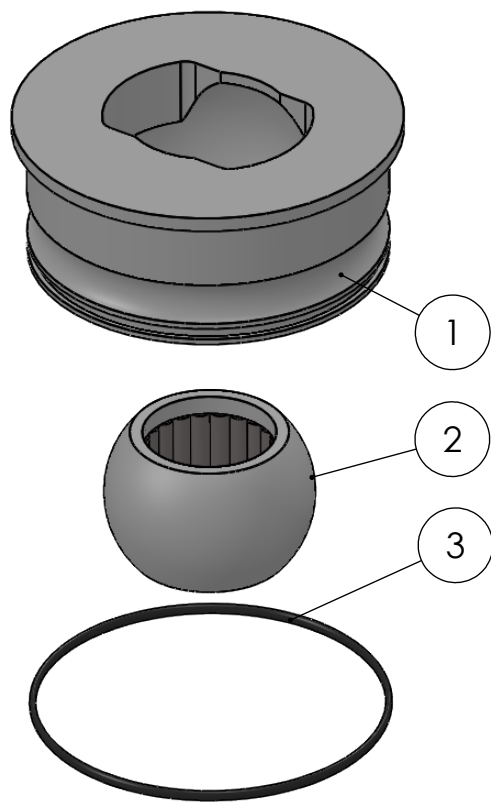
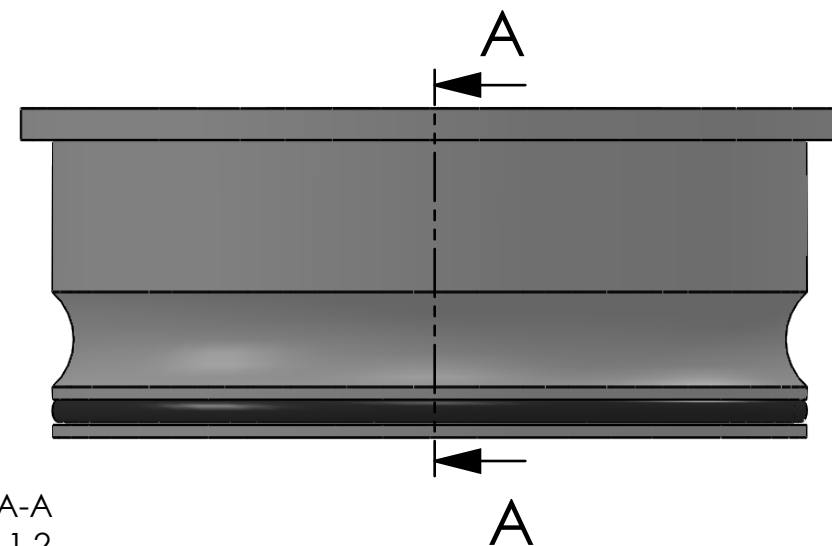

ITEM NO.	PART NUMBER	PART NAME	QTY.
1	M48-142	House ø120mm for ø70mm Ball	1
2	M13-115-43	Ball with rollers for Ø43mm	1
3	O-ring	ø110 x 2.5	1

DWG NR / NAME: 6BF120043 / S-A Top Roller bearing				BATCH NR:		<i>Jefa Rudder</i> SYSTEMS
PROJECT: Shaft Ø43mm				REKV.NR / ORDRE NR:		
DATE: 12.09.2016	NAME: JR	SCALE / PAPER: 1:2,5 / A4	MATERIAL: PETP	LOCATION:	ORDRE DATO:	JEFA MARINE A/S NIMBUSVEJ 2 2670 GREVE. DENMARK Tlf: +45 4615 5210 & Fax: +45 46155208 Email: info@jefa.com www.jefa.com
MODIFY DATE: : /			WEIGHT: g	REV:	LEV.DATO:	