

SECTION A-A
SCALE 1 : 1.2

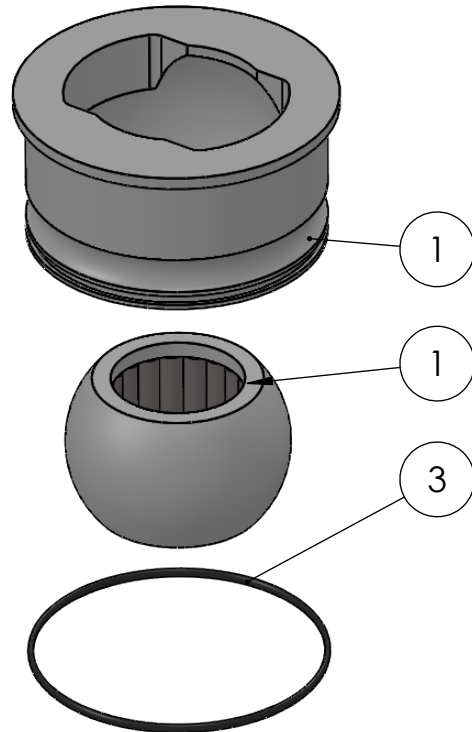

ITEM NO.	PART NUMBER	PART NAME	QTY.
1	M48-144	House $\varnothing 120\text{mm}$ for $\varnothing 90\text{mm}$ Ball	1
2	M13-161-53	Ball with rollers for $\varnothing 53\text{mm}$	1
3	O-ring	$\varnothing 110 \times 2.5$	1

DWG NR / NAME: 6BF120053 / S-A Top Roller bearing				BATCH NR:		<i>Jefa Rudder</i> S Y S T E M S
PROJECT: Shaft $\varnothing 53\text{mm}$				REKV.NR / ORDRE NR:		
DATE: 12.09.2016	NAME: JR	SCALE / PAPER: 1:3 / A4	MATERIAL: PETP	LOCATION:	ORDRE DATO:	JEFA MARINE A/S NIMBUSVEJ 2 2670 GREVE. DENMARK Tlf: +45 4615 5210 & Fax: +45 46155208 Email: info@jefa.com www.jefa.com
MODIFY DATE: : /			WEIGHT: g	REV:	LEV.DATO:	